



KATALOG  
EKSKLUZIVNIH  
ULAZNIH VRATA

---

# SADRZAJ

Tehnički podaci 3

Ulazna vrata

Modeli bez stakla 5

Modeli sa staklom 13

Oprema 21





## Ekskluzivna ulazna vrata

Ulazna vrata su jedan od najvažnijih građevinskih komponenti cele fasade. S jedne strane, ona moraju da izoluju toplotu i zvuk, pružaju zaštitu od provalnika i stvori estetski prijatan eksterijer kuće.

S druge strane, vrata moraju biti jednostavna za upotrebu a zahtevi održavanja niski. Moderna aluminijumska ulazna vrata lako ispunjavaju ove uslove: štite od vetra i vremenskih prilika, nepremostive su prepreke za provalnika i stvaraju jedinstveni izgled kuće.

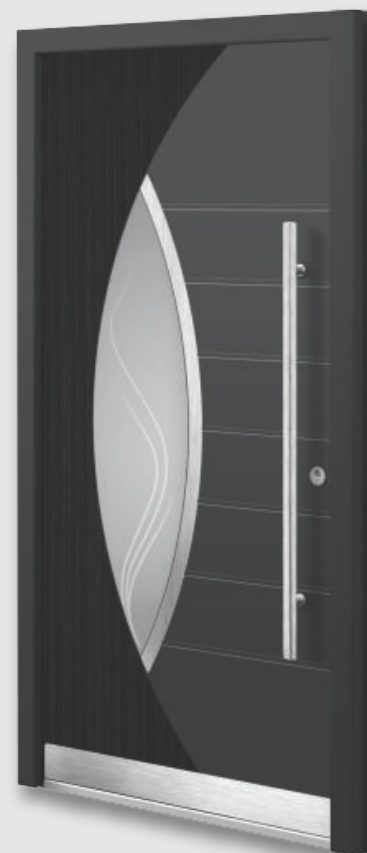

---

Bezbednost je, pored dugovečnosti, jedan od glavnih prednosti ulaznih vrata od aluminijuma. Veoma je teško za provalnika da prodje kroz vrata bez upotrebe teških alata.

Dok drveni elementi mogu biti iščupani iz okvira a PVC-prozori mogu da se deformišu uz pomoć odgovarajućih alata, elementi od aluminijuma su tesko lomljive komponente.



## Aluminijum materijal prijatan za okolinu

Aluminijum je lak metal. Bilo koja ulazna vrata od čistih lakih metala imaju tendenciju da sprovede toplotu, umesto da je izoluju. Višekomorni sistemi takodje obično imaju problema sa gubitkom toplote.

Ali, savremena ulazna vrata od aluminijuma imaju visoka termoizolaciona svojstva zahvaljujući specijalno konstruisanim profilima sa termo prekidom, ispunom od stirodura i višeslojnog termoizolacionog stakla.



- Ulazna vrata sa obostrano skrivenim krilom debljine 77 mm
- **3 tačke** sigurnosnog zaključavanja
- lim debljine 3mm sa spoljašnje i unutrašnje strane
- **termo prekid** u profilima obezbeđuje trajnu toplotnu izolaciju, čime je sprečeno provođenje toplote po preseku profila
- Ispuna od stirodura (XPS-50)
- Četvoroslojna izolaciona stakla Ug vrednosti do  $0,6 \text{ W/m}^2 \text{ K}$  u kombinaciji sa motivima i različitim ornamentnim staklima

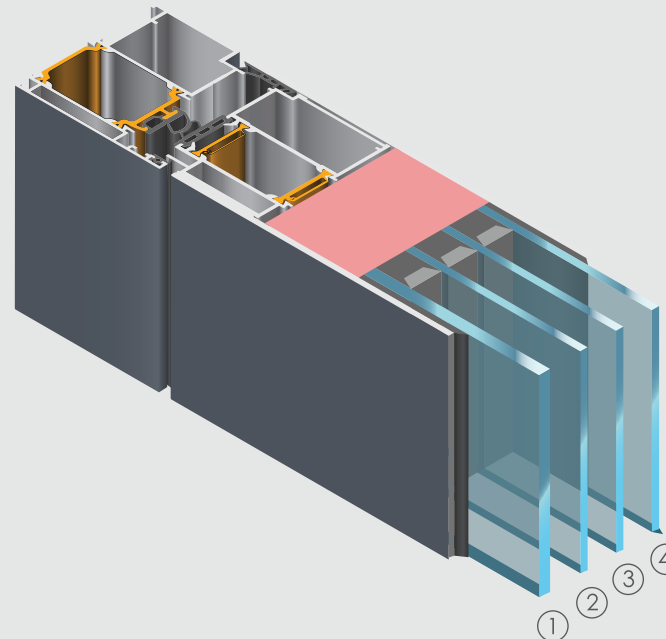

### Standardno zastakljivanje

- 1 – float (VSG 3.3.1.) 6mm
- 2 – float 4mm
- 3 – float 4mm
- 4 – float (VSG 3.3.1.) 6mm

(Ug vrednost do  $0,6 \text{ W/m}^2 \text{ K}$ )





## SISTEMI PROFILA

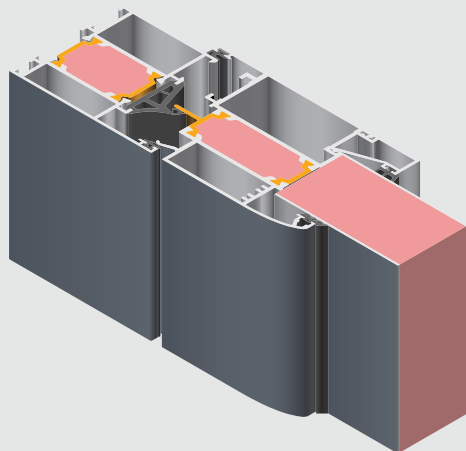

**CLASSIC AG 70**

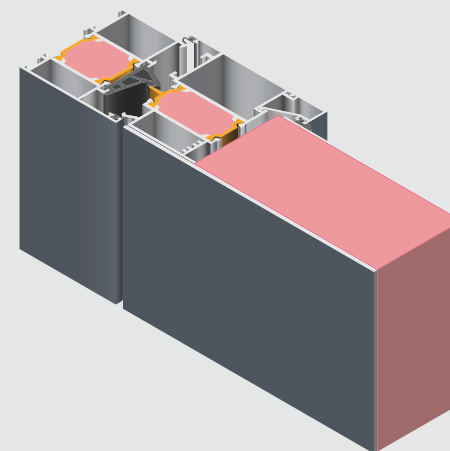

**STANDARD AG 70**

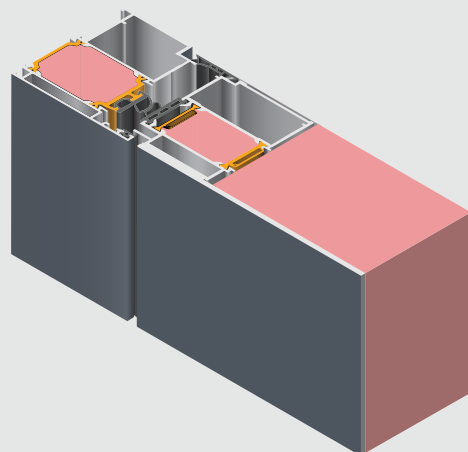

**EXCLUSIVE AG 77**

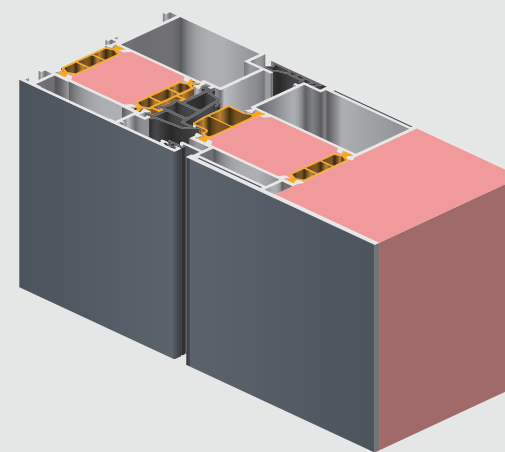

**PREMIUM AG 85**

## Modeli bez stakla

Odlikuju ih glatke površine, čiste i jednostavne linije. Osnovni oblici modela su jednostavni, skladni što pruža savremeni izgled modelima.

Stroga kontrola kroz ceo tehnološki proces izrade i završna kontrola ekskluzivnih modela bez stakla pružaju, sa minimalnim održavanjem, jako dug period upotrebe. Svakom modelu iz ove grupe slobodno dodajte svoju individualnu notu oblikovanja i ostvarite u potpunosti svoj unikatni izgled ekskluzivnih ulaznih vrata.



AL 201



AL 202

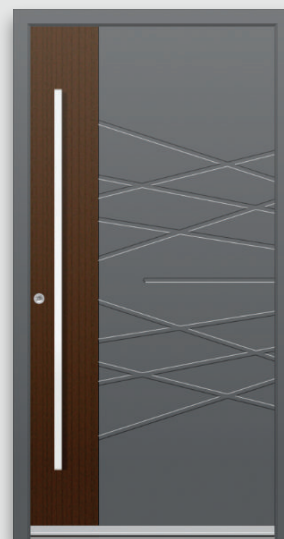

AL 203



AL 204



AL 205



AL 206



AL 207



AL 207



AL 208



AL 209



AL 210





AL 211



AL 212



AL 213



AL 214

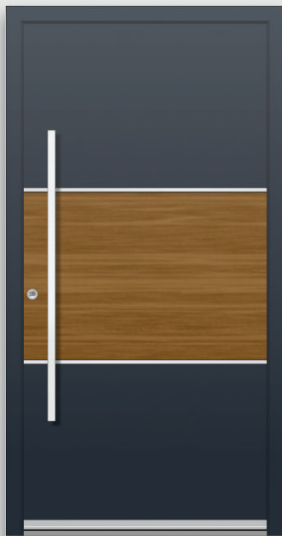

AL 215



AL 216



AL 217



AL 218



AL 219

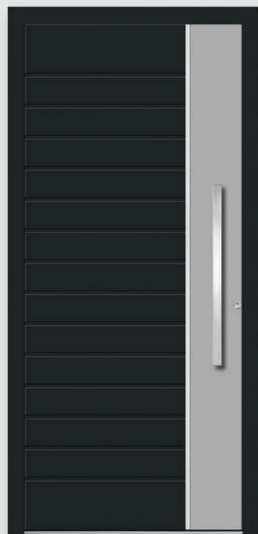

AL 220



AL 221



AL 222



AL 223



AL 224



AL 225

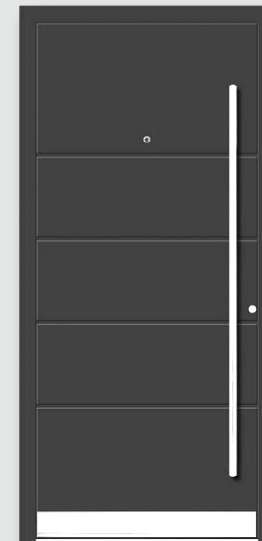

AL 226



AL 227



AL 228

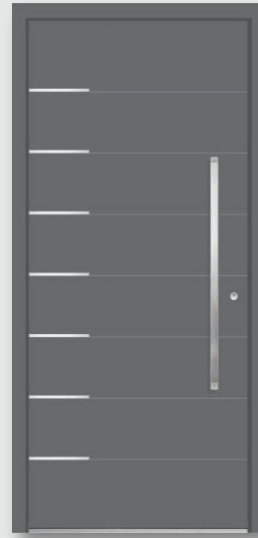

AL 229



AL 230

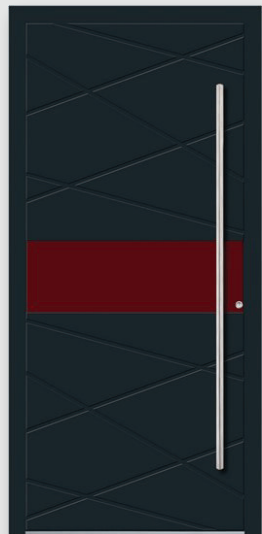

AL 231

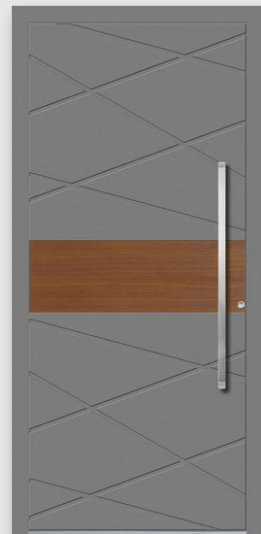

AL 232

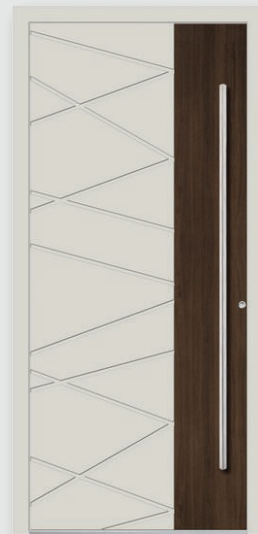

AL 233



AL 234





AL 235



AL 236



AL 237



AL 238



AL 239

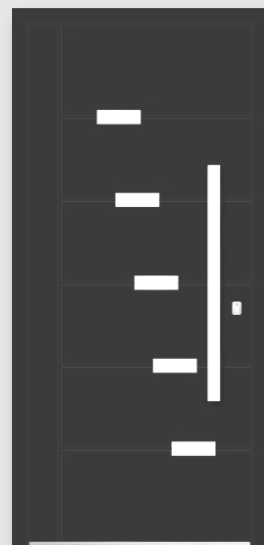

AL 240

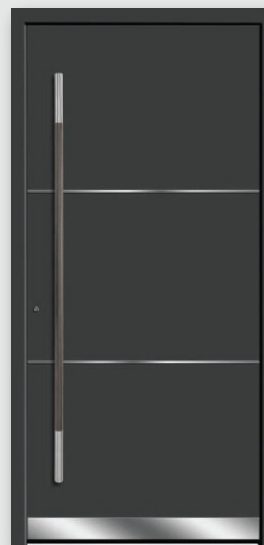

AL 241

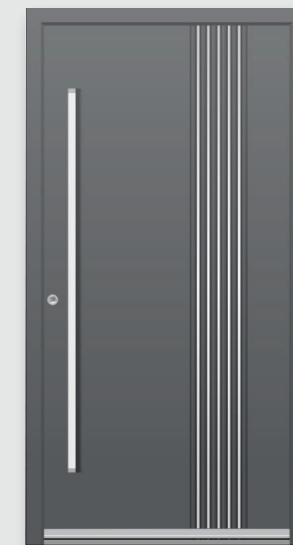

AL 242



AL 243



AL 244

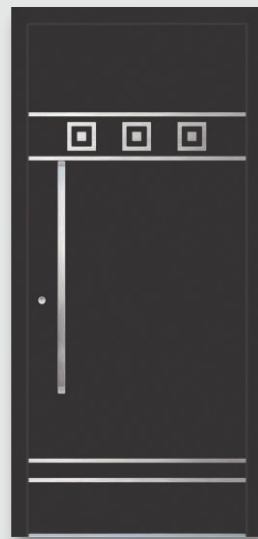

AL 245

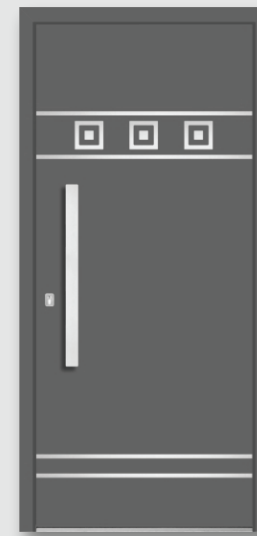

AL 246



AL 247

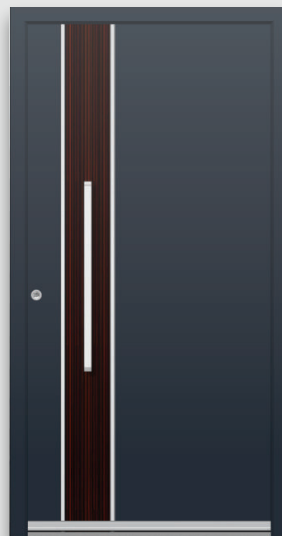

AL 248



AL 249



AL 250



AL 251



AL 252



AL 253



AL 254



AL 255

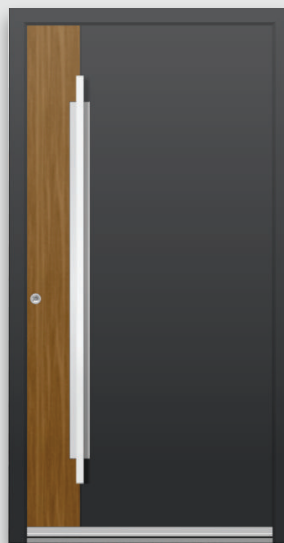

AL 256



AL 257

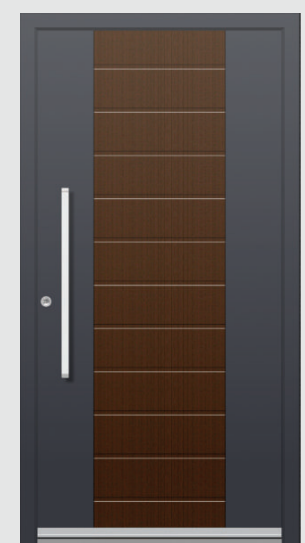

AL 258



## Modeli sa staklom

Odlikuje ih kombinacija više različitih materijala, kao što su aluminijum, inoks i staklo koji zajedno stvaraju izrazite linije i daju ulaznim vratima poseban pečat.

Stroga kontrola kroz ceo tehnološki proces izrade i završna kontrola ekskluzivnih modela sa staklima pružaju, sa minimalnim održavanjem, jako dug period upotrebe. Svakom modelu iz ove grupe slobodno dodajte svoju individualnu notu oblikovanja i ostvarite u potpunosti svoj unikatan izgled ekskluzivnih ulaznih vrata.



AL 259

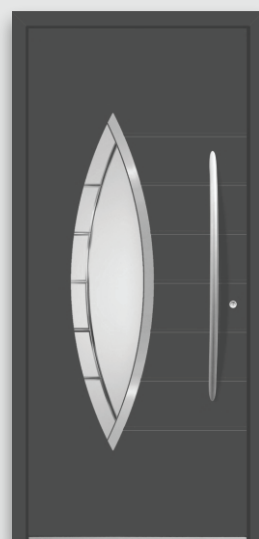

AL 260

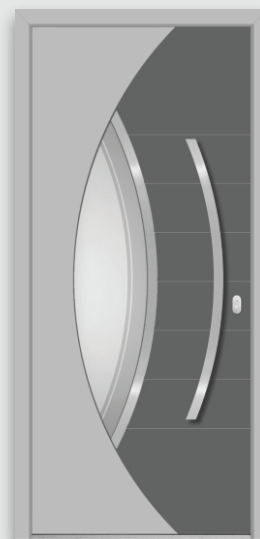

AL 261



AL 262

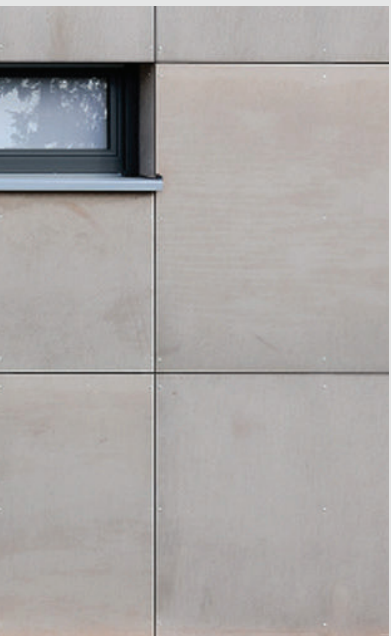

AL 263



AL 264

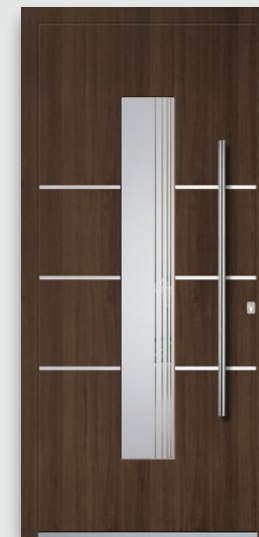

AL 265



AL 266



AL 267

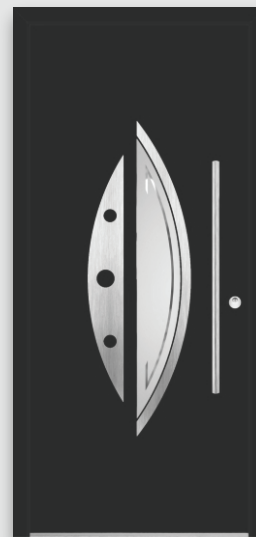

AL 268



AL 269



AL 270



AL 271



AL 272

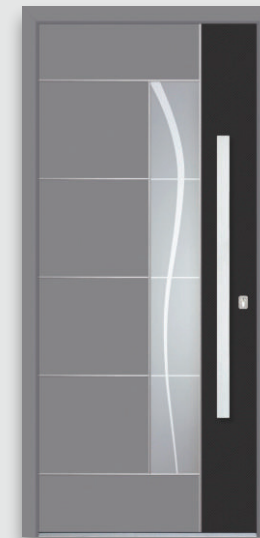

AL 273



AL 274



AL 275



AL 276

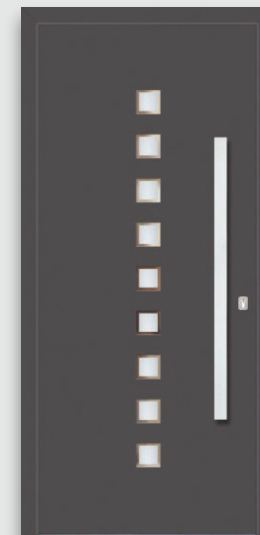

AL 277





AL 278



AL 279



AL 280



AL 281

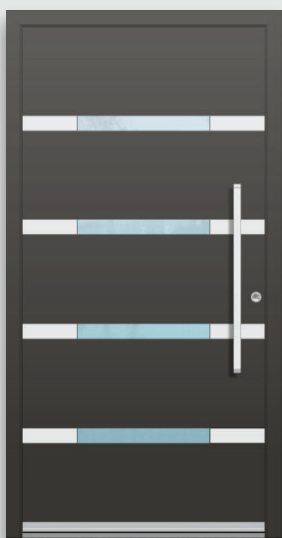

AL 282



AL 283



AL 284

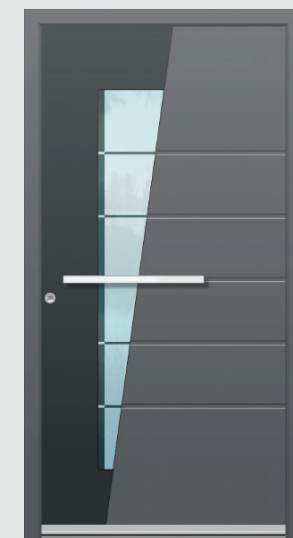

AL 285



AL 286



AL 287



AL 288

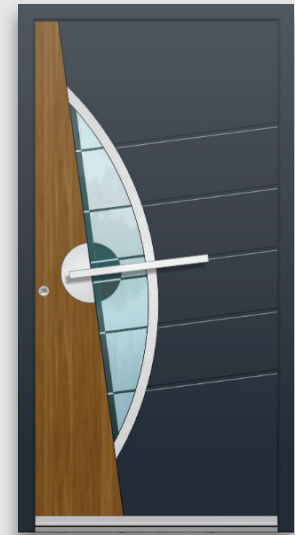

AL 289

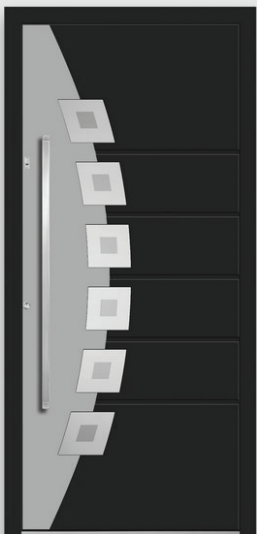

AL 290



AL 291

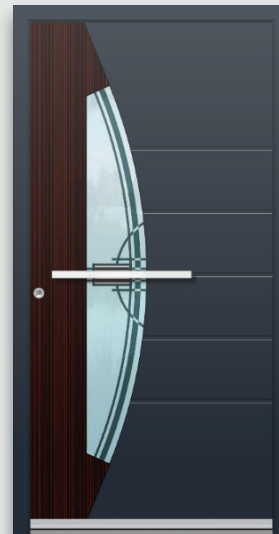

AL 292



AL 293

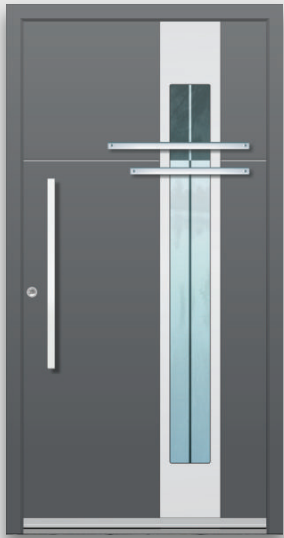

AL 294



AL 295



AL 296



AL 297



AL 298



AL 299

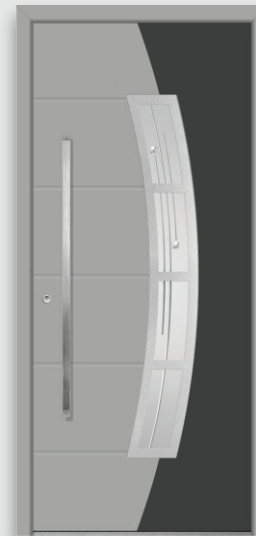

AL 301



AL 302





AL 303



AL 304



AL 305



AL 306



AL 307



AL 308

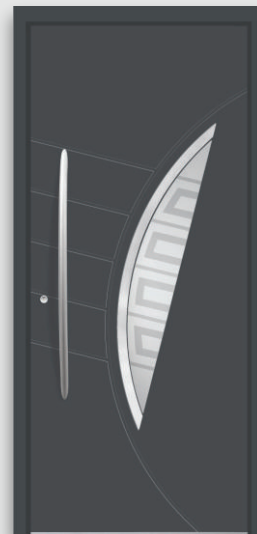

AL 309

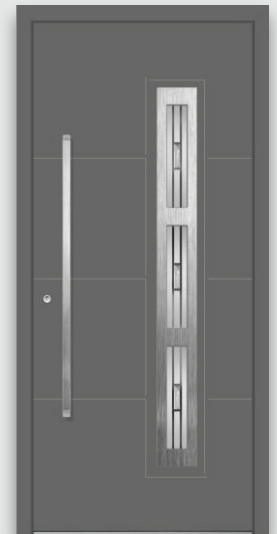

AL 310



AL 311



AL 312



AL 313



AL 314

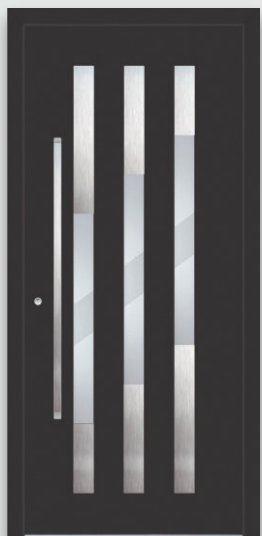

AL 315



AL 316



AL 317

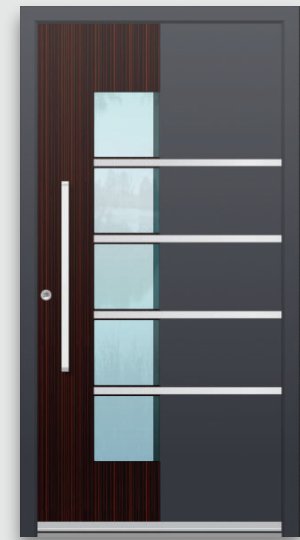

AL 318

# Oprema

**Rukohvati** - od inoksa dimenzija od 400 do 1600 mm

**Brave sa trostrukim zaključavanjem** - sa motorom i bez motora

**Cilindri** - standardni i kodirani

**Čitači otiska i šifратор**

**Kućni brojevi**







